

Metal Center

Profili in alluminio per

# PARAPETTI E STECCATI

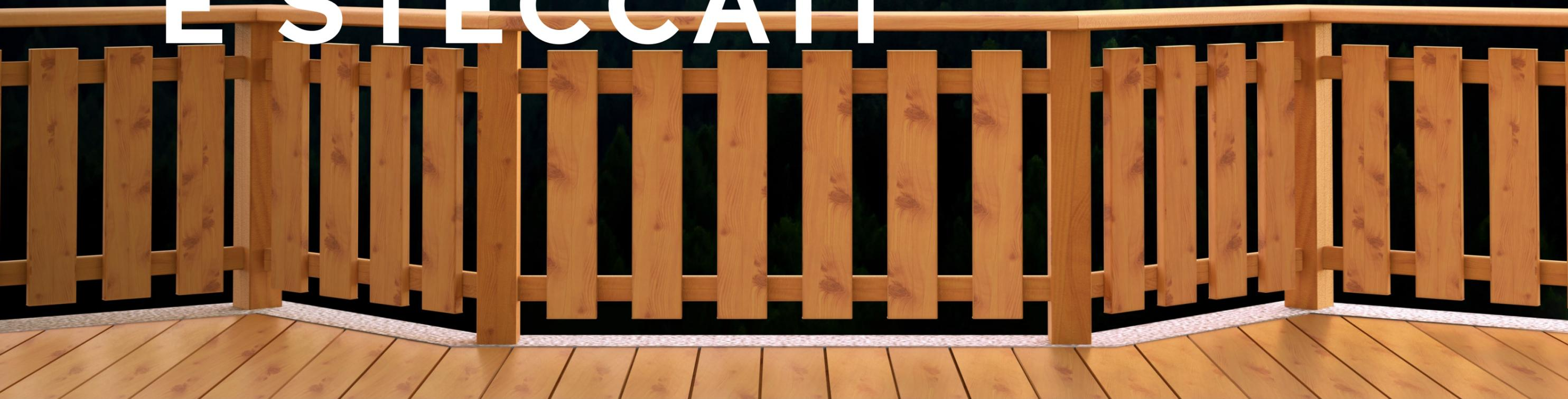



**MCSTEC040**  
40 x 20 mm

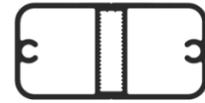

**MCSTEC048**  
50 x 25 mm



**MCSTEC053**  
80 x 25 mm



**MCSTEC047**  
110 x 25 mm



**MCSTEC050**  
100 x 25 mm

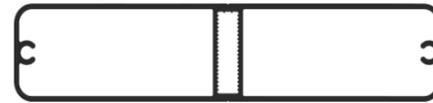

**MCSTEC110**  
110 x 25 mm



**MCSTEC049**  
120 x 25 mm



**MCSTEC052**  
150 x 25 mm



**MCSTEC054**  
200 x 25 mm

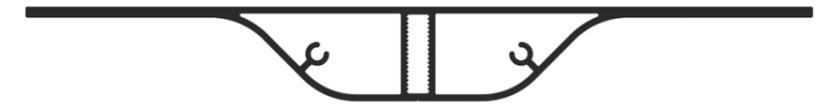

**MCSTEC056**  
210 x 25 mm



**MCSTEC088**  
147 x 10 mm



**MCSTEC130**  
40 x 40 mm

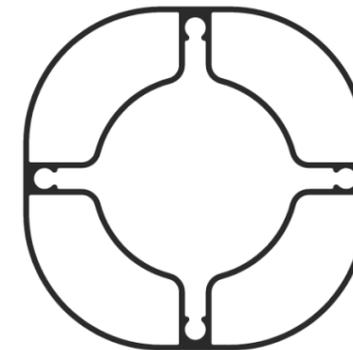

**MCSTEC060**  
90 x 90 mm

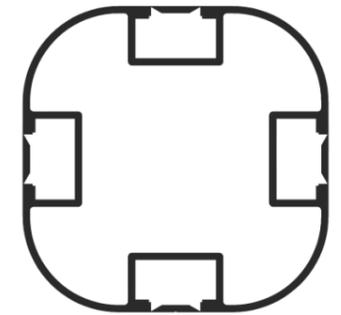

**MCSTEC080**  
80 x 80 mm

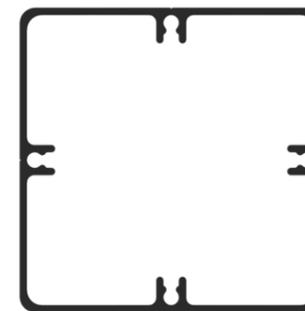

**MCSTEC082**  
80 x 80 mm



**MCSTEC081**  
30,5 x 53,4 mm



**MCSTEC086**  
30,7 x 40 mm

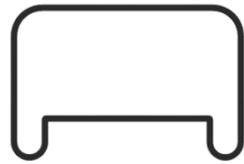

**MCSTEC145**  
60 x 40 mm



**MCSTEC150**  
138 x 37 mm



**MCSTEC140**  
110 x 41 mm

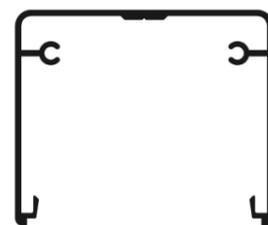

**MCSTEC139**  
66 x 55 mm



**MCSTEC137**  
70 x 20 mm



**MCSTEC136**  
60 x 14 mm



**PAD35498**  
110 x 37 mm

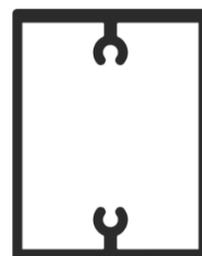

**PAD35499**  
50 x 65 mm



## TINTE RAL

Tramite un processo di **verniciatura a polvere certificata Qualicoat**, garantiamo standard elevati di qualità e durabilità.

Durante questo processo, la polvere di vernice viene applicata al materiale e successivamente polimerizzata in forno ad alte temperature. Il risultato è un rivestimento uniforme e robusto, altamente resistente agli agenti atmosferici e ai raggi UV, ideale per applicazioni sia interne che esterne. La certificazione **Qualicoat** assicura che ogni fase della produzione rispetti rigorosi criteri di controllo qualità, offrendo un prodotto finale che combina estetica e prestazioni superiori.

## TINTA LEGNO

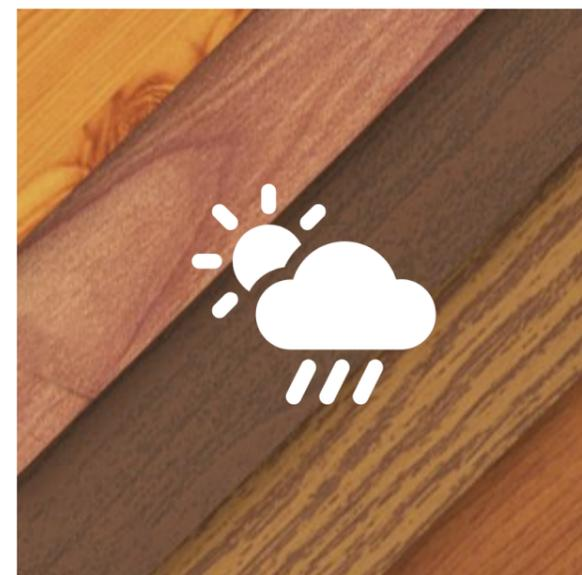

La finitura in tinta legno è prodotta utilizzando una tecnologia basata sul processo fisico della **sublimazione** in cui degli speciali inchiostri vengono trasferiti mediante combinazione di calore e pressione al primo strato di **vernice a polvere** applicato in precedenza sul materiale.

Ne deriva un materiale fortemente **resistente agli agenti atmosferici**, particolarmente indicato per applicazioni all'esterno.

## File CAD profili

(cliccare sulle immagini del formato)

CODICE	DESCRIZIONE	FILE CAD	
MCSTEC040	PROFILO TRAVERSO 40x20 mm	 .dwg	 DXF
MCSTEC047	PROFILO PERLINA A TRAPEZIO 110x25 mm con occhi	 .dwg	 DXF
MCSTEC048	PROFILO PERLINA 50x25 mm con anima e occhi vite	 .dwg	 DXF
MCSTEC049	PROFILO PERLINA 120x25 mm con anima e occhi vite	 .dwg	 DXF
MCSTEC050	PROFILO PERLINA 100x25 mm con anima e occhi vite	 .dwg	 DXF
MCSTEC052	PROFILO PERLINA 150x25 mm con anima e occhi vite	 .dwg	 DXF
MCSTEC053	PROFILO PERLINA A TRAPEZIO 80x25 mm con occhi	 .dwg	 DXF
MCSTEC054	PROFILO PERLINA 200x25 mm con anima e occhi vite	 .dwg	 DXF
MCSTEC056	PROFILO PERLINA 210x25 mm con ali	 .dwg	 DXF
MCSTEC060	PROFILO PALO ARROTONDATO 90x90 mm	 .dwg	 DXF
MCSTEC080	PROFILO PALO RAGGIATO 80x80 mm	 .dwg	 DXF
MCSTEC081	PROFILO ad H conn. MCSTEC080 <—> PERLINE	 .dwg	 DXF
MCSTEC082	PROFILO PALO QUADRO 80x80 mm	 .dwg	 DXF
MCSTEC086	PROFILO ad U di chiusura per perline da 25mm	 .dwg	 DXF
MCSTEC088	PROFILO PER TAMPONAMENTI dim.146,8 x 10 mm	 .dwg	 DXF
MCSTEC130	PROFILO QUADRO RAGGIATO 40x40 mm	 .dwg	 DXF
MCSTEC136	PROFILO BASETTA A SCATTO 60x14 mm	 .dwg	 DXF
MCSTEC137	PROFILO SPALLETTA 70x20 mm	 .dwg	 DXF
MCSTEC139	SPALLA A SCATTO 66x55 mm	 .dwg	 DXF
MCSTEC140	PROFILO CORRIMANO RAGGIATO 110x41 mm	 .dwg	 DXF
MCSTEC145	PROFILO CORRIMANO 60x40 mm	 .dwg	 DXF
MCSTEC150	PROFILO CORRIMANO RAGGIATO 138x37 mm	 .dwg	 DXF



**MCSTEC030**  
Tappo in plastica nero



## MCSTEC040

PROFILO TRAVERSO 40x20 mm  
BARRE L= 6500 mm

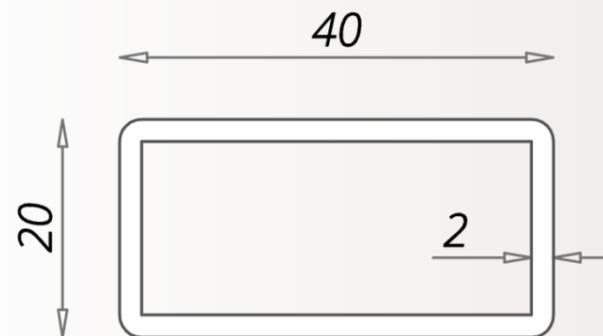

**Cod. :**

**MCSTEC040GR:** Grezzo

**MCSTEC040VR:** Verniciato RAL

**MCSTEC040VX:** Verniciato legno

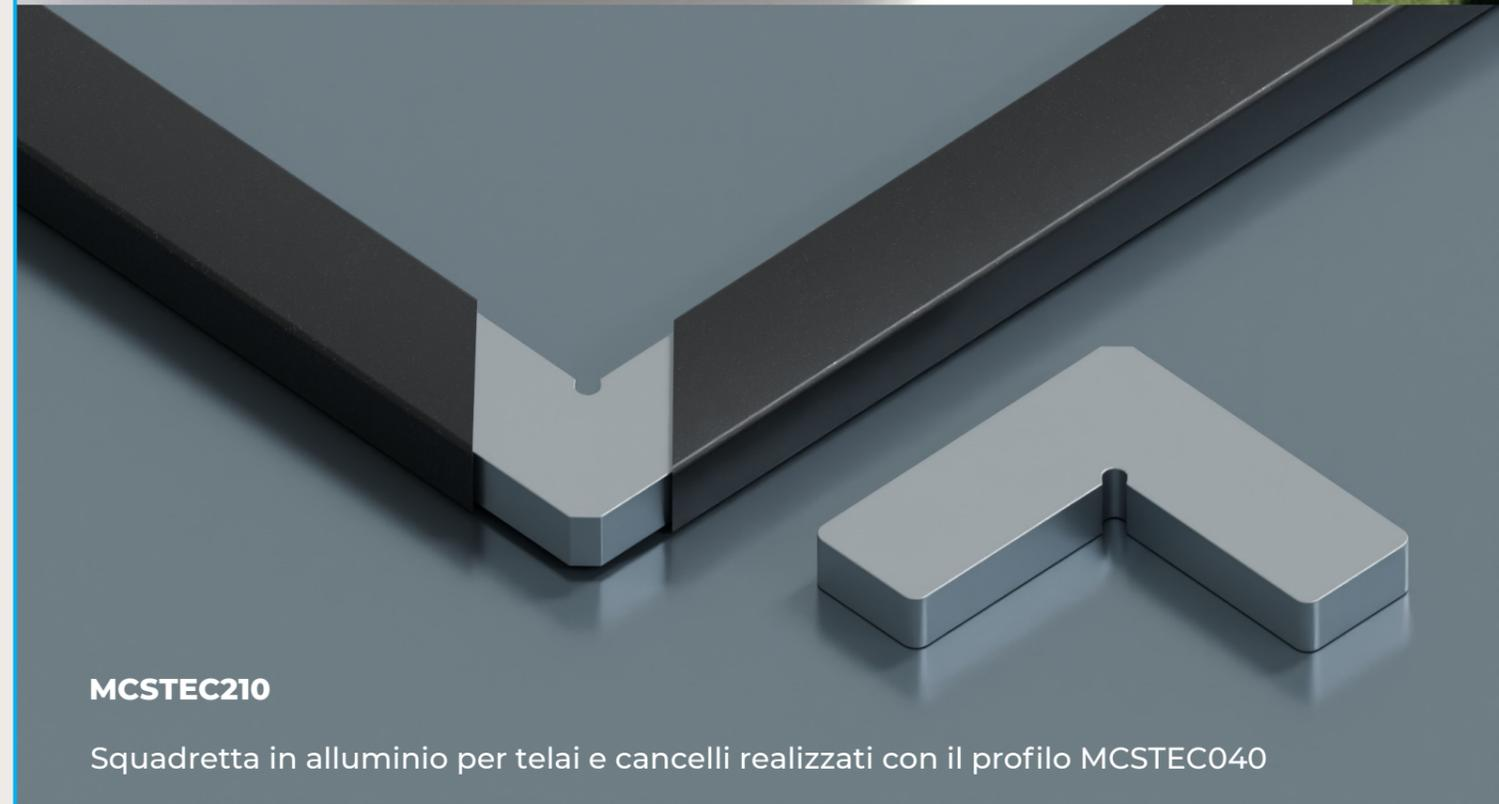

## MCSTEC210

Squadretta in alluminio per telai e cancelli realizzati con il profilo MCSTEC040



# MCSTEC048

PROFILO PERLINA 50x25 mm CON ANIMA  
E OCCHI VITE  
BARRE L= 6600 mm

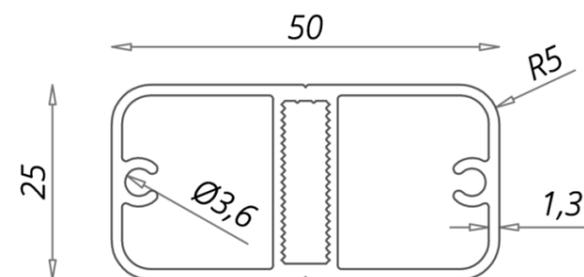

Cod. :

**MCSTEC048GR:** Grezzo

**MCSTEC048VR:** Verniciato RAL

**MCSTEC048VX:** Verniciato legno

UTILIZZATO NELL'ASSEMBLAGGIO DI PARETI FRANGISOLE E BALCONI "ALLA TRENTINA".



## MCSTEC009ZS

Tappo in plastica sublimato  
**EFFETTO LEGNO - Tinte a richiesta**  
(lotto minimo: 51 pezzi per colore)

## MCSTEC009ZR

Tappo in plastica disponibile in **tinte RAL**  
(lotto minimo: 51 pezzi per colore)

Per perlina 50x25 mm. MCSTEC048



## MCSTEC009

Tappo in plastica foto inciso  
disponibile:

**MCSTEC009N** - Nero

**MCSTEC009M** - Marrone

**MCSTEC009OCRA** - Ocra

(Altri colori a richiesta, con lotto minimo di  
300pz)

Per perlina 50x25 mm. MCSTEC048



## MCSTEC048ZZ01VR

Tappo alluminio verniciato\*\* RAL

## MCSTEC048ZZ01VX

Tappo alluminio verniciato\*\* legno

## MCSTEC048ZZ01GR

Tappo alluminio grezzo

Per perlina 50x25 mm. MCSTEC048

\*\*La quotazione a listino dei terminali in metallo verniciati è valida se abbinata a lotto di almeno 150 kg di profili nella stessa tinta oppure per lotti minimi di almeno 50 pezzi. Differentemente sarà da concordare



# MCSTEC050

PROFILO PERLINA 100x25 mm CON ANIMA E OCCHI VITE  
BARRE L= 6600 mm

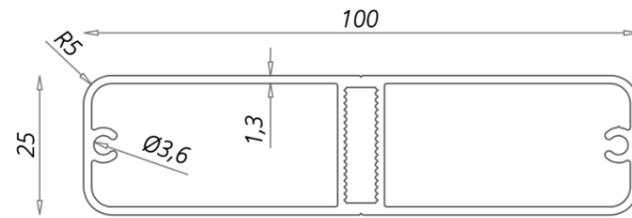

**Cod.:**

- MCSTEC050GR:** Grezzo
- MCSTEC050VR:** Verniciato RAL
- MCSTEC050VX:** Verniciato legno

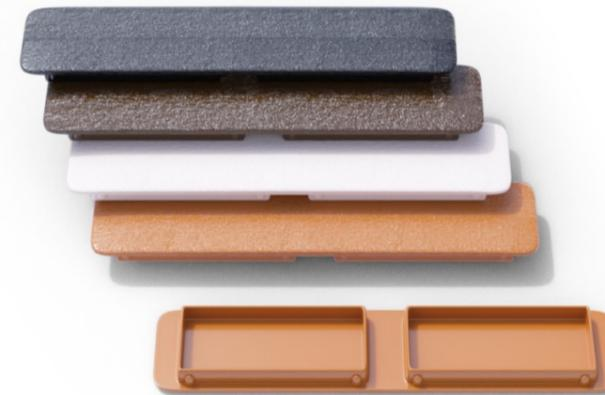

## MCSTEC010

Tappo in plastica foto inciso disponibile:

- MCSTEC010N** - Nero
- MCSTEC010M** - Marrone
- MCSTEC010OCRA** - Ocra

(Altri colori a richiesta, con lotto minimo di 300pz)

Per perlina 100x25 mm. MCSTEC050



Esempi di finitura

## MCSTEC010ZS

Tappo in plastica sublimato  
**EFFETTO LEGNO - Tinte a richiesta**  
(lotto minimo: 51 pezzi per colore)

## MCSTEC010ZR

Tappo in plastica disponibile in **tinte RAL**  
(lotto minimo: 51 pezzi per colore)

Per perlina 100x25 mm. MCSTEC050



## MCSTEC050ZZ01VR

Tappo alluminio verniciato\*\* RAL

## MCSTEC050ZZ01VX

Tappo alluminio verniciato\*\* legno

## MCSTEC050ZZ01GR

Tappo alluminio grezzo

Per perlina 100x25 mm. MCSTEC050

\*\*La quotazione a listino dei terminali in metallo verniciati è valida se abbinata a lotto di almeno 150 kg di profili nella stessa tinta oppure per lotti minimi di almeno 50 pezzi. Differentemente sarà da concordare



# MCSTEC110

PROFILO PERLINA 110x25 mm CON  
ANIMA E OCCHI VITE  
BARRE L= 6600 mm

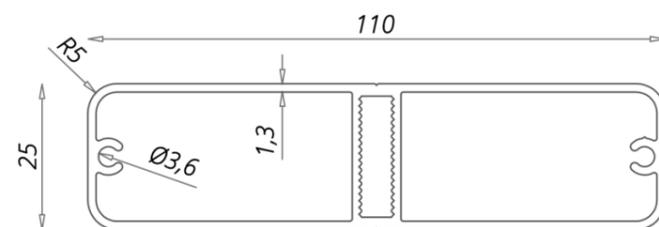

**Cod.:**

**MCSTEC110GR:** Grezzo

**MCSTEC110VR:** Verniciato RAL

**MCSTEC110VX:** Verniciato legno



**MCSTEC110ZZ01VR**

Tappo alluminio verniciato\*\* RAL

**MCSTEC110ZZ01VX**

Tappo alluminio verniciato\*\* legno

**MCSTEC110ZZ01GR**

Tappo alluminio grezzo

Per perlina 110x25 mm. MCSTEC110

\*\*La quotazione a listino dei terminali in metallo verniciati è valida se abbinata a lotto di almeno 150 kg di profili nella stessa tinta oppure per lotti minimi di almeno 50 pezzi. Differentemente sarà da concordare





# MCSTEC049

PROFILO PERLINA 120x25 mm  
CON ANIME E OCCHI VITE

BARRE L= 6600 mm

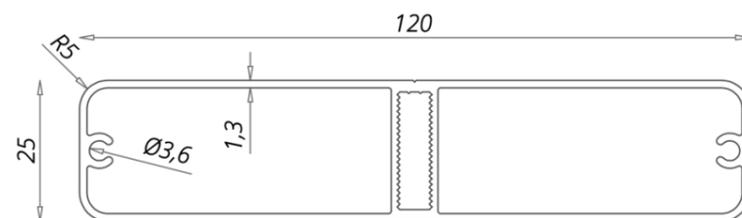

**Cod.:**

**MCSTEC049GR:** Grezzo

**MCSTEC049VR:** Verniciato RAL

**MCSTEC049VX:** Verniciato legno



**MCSTEC011**

Tappo in plastica foto inciso  
disponibile:

**MCSTEC011N** - Nero

**MCSTEC011M** - Marrone

**MCSTEC011OCRA** - Ocra

(Altri colori a richiesta, con lotto minimo di  
300pz)

Per perlina 120x25 mm. MCSTEC049



Esempi di finitura



**MCSTEC011ZS**

Tappo in plastica sublimato  
**EFFETTO LEGNO - Tinte a richiesta**  
(lotto minimo: 51 pezzi per colore)

**MCSTEC011ZR**

Tappo in plastica disponibile in **tinte RAL**  
(lotto minimo: 51 pezzi per colore)

Per perlina 120x25 mm. MCSTEC049



**MCSTEC049ZZ01VR**

Tappo alluminio verniciato\*\* RAL

**MCSTEC049ZZ01VX**

Tappo alluminio verniciato\*\* legno

**MCSTEC049ZZ01GR**

Tappo alluminio grezzo

Per perlina 120x25 mm. MCSTEC049

\*\*La quotazione a listino dei terminali in metallo verniciati è valida se abbinata a lotto di almeno 150 kg di profili nella stessa tinta oppure per lotti minimi di almeno 50 pezzi. Differentemente sarà da concordare



# MCSTEC052

Cod. :

**MCSTEC052GR:** Grezzo

**MCSTEC052VR:** Verniciato RAL

**MCSTEC052VX:** Verniciato legno

PROFILO PERLINA 150x25 mm  
CON ANIME E OCCHI VITE

BARRE L= 6600 mm

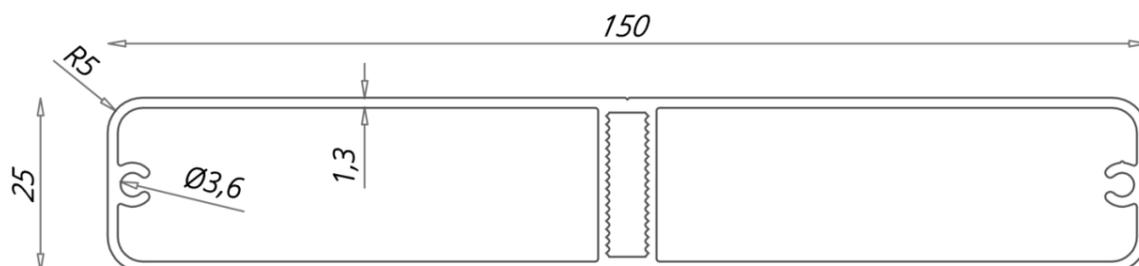

## MCSTEC012

Tappo in plastica foto inciso  
disponibile:

**MCSTEC012N** - Nero

**MCSTEC012M** - Marrone

**MCSTEC012OCRA** - Ocra

(Altri colori a richiesta, con lotto minimo di 300pz)

Per perlina 150x25 mm. MCSTEC051



Esempi di finitura

## MCSTEC012ZS

Tappo in plastica sublimato

**EFFETTO LEGNO - Tinte a richiesta**

(lotto minimo: 51 pezzi per colore)

## MCSTEC012ZR

Tappo in plastica disponibile in **tinte RAL**  
(lotto minimo: 51 pezzi per colore)

Per perlina 150x25 mm. MCSTEC052



## MCSTEC052ZZ01VR

Tappo alluminio verniciato\*\* RAL

## MCSTEC052ZZ01VX

Tappo alluminio verniciato\*\* legno

## MCSTEC052ZZ01GR

Tappo alluminio grezzo

Per perlina 150x25 mm. MCSTEC052

\*\*La quotazione a listino dei terminali in metallo verniciati è valida se abbinata a lotto di almeno 150 kg di profili nella stessa tinta oppure per lotti minimi di almeno 50 pezzi. Differentemente sarà da concordare



# MCSTEC054

PROFILO PERLINA 200x25 mm  
CON OCCHI VITE

BARRE L= 6600 mm

**Cod. :**

**MCSTEC054GR:** Grezzo

**MCSTEC054VR:** Verniciato RAL

**MCSTEC054VX:** Verniciato legno

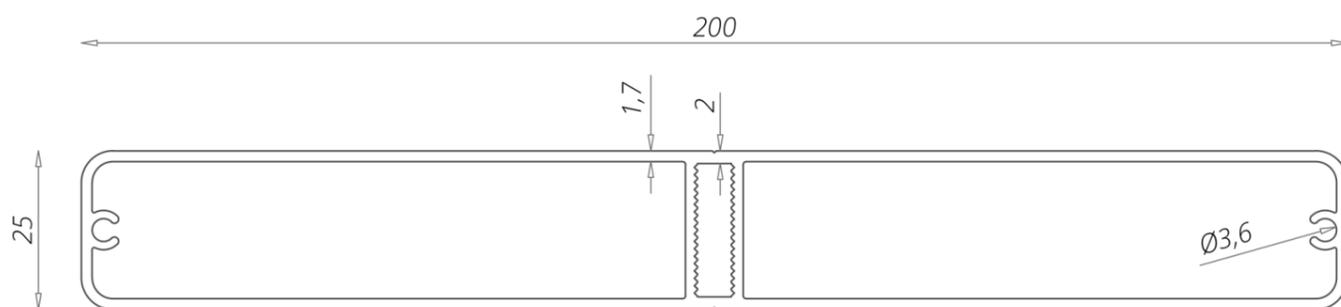

## MCSTEC014

Tappo in plastica foto inciso  
disponibile:

**MCSTEC014N** - Nero

**MCSTEC014M** - Marrone

**MCSTEC014OCRA** - Ocra

(Altri colori a richiesta, con lotto minimo di  
300pz)

Per perlina 200x25 mm. MCSTEC054



ESEMPIO APPLICAZIONE D'USO



## MCSTEC054ZZ01VR

Tappo alluminio verniciato\*\* RAL

## MCSTEC054ZZ01VX

Tappo alluminio verniciato\*\* legno

## MCSTEC054ZZ01GR

Tappo alluminio grezzo

Per perlina 200x25 mm. MCSTEC054

\*\*La quotazione a listino dei terminali in metallo verniciati è valida se abbinata a lotto di almeno 150 kg di profili nella stessa tinta oppure per lotti minimi di almeno 50 pezzi. Differentemente sarà da concordare



# MCSTEC056

PROFILO PERLINA 210x25 mm  
CON ALI  
BARRE L= 6600 mm

Cod. :

**MCSTEC056GR:** Grezzo

**MCSTEC056VR:** Verniciato RAL

**MCSTEC056VX:** Verniciato legno

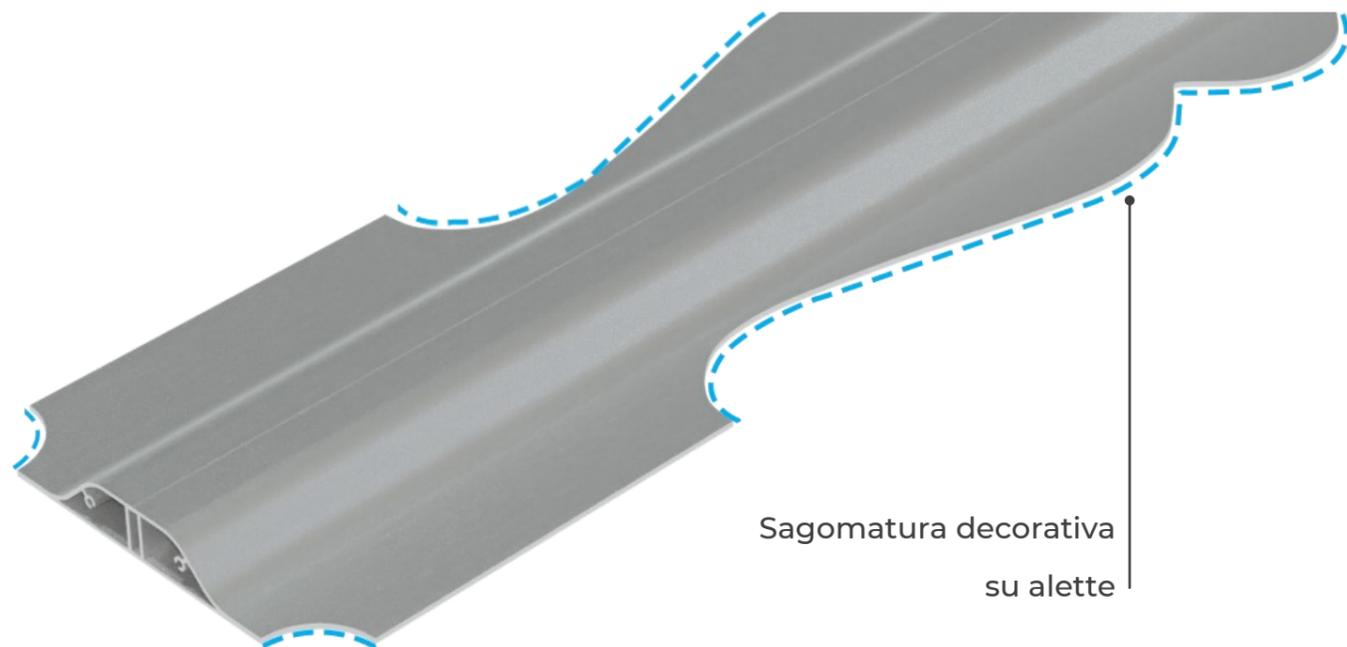
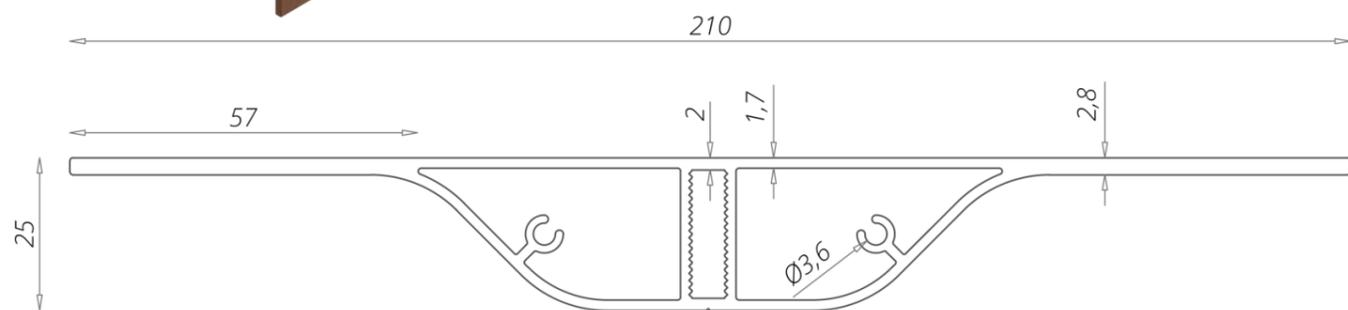

Sagomatura decorativa  
su alette



LA LAVORAZIONE  
DELLE ALETTE  
LATERALI CONSENTE  
UNA PIENA LIBERTÀ  
NELLA DECORAZIONE  
DELLA PERLINA

(alcuni esempi  
nel disegno a fianco)





**MCSTEC056ZZ01VR**

Tappo alluminio verniciato\*\* RAL

**MCSTEC056ZZ01VX**

Tappo alluminio verniciato\*\* legno

**MCSTEC056ZZ01GR**

Tappo alluminio grezzo

Per perlina obliqua 210x25 mm  
MCSTEC056

\*\*La quotazione a listino dei terminali in metallo verniciati è valida se abbinata a lotto di almeno 150 kg di profili nella stessa tinta oppure per lotti minimi di almeno 50 pezzi. Differentemente sarà da concordare

# MCSTEC053

PROFILO PERLINA 80x25 mm  
CON OCCHI VITE

BARRE L= 6600 mm

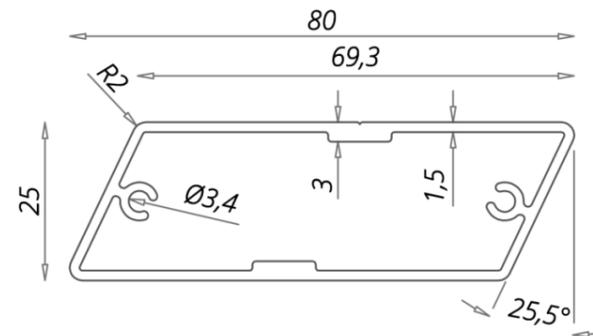

Cod. :

**MCSTEC053GR:** Grezzo

**MCSTEC053VR:** Verniciato RAL

**MCSTEC053VX:** Verniciato legno



Profilo ad H di connessione  
MCSTEC080 <—> PERLINE

**MCSTEC081GR**  
Alluminio grezzo

**MCSTEC081VR**  
Tinte RAL con lotti minimi

**MCSTEC081VX**  
Tinte Legno con lotti minimi

Barre L.6000 mm

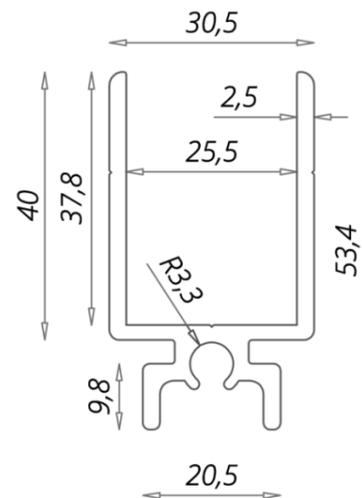

Profilo ad U di chiusura

**MCSTEC086GR**  
Alluminio grezzo

**MCSTEC086VR**  
Tinte RAL con lotti minimi

**MCSTEC086VX**  
Tinte Legno con lotti minimi

Barre L.6000 mm

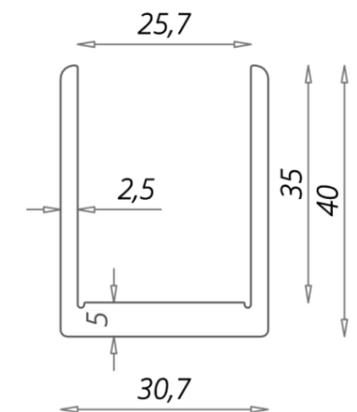

**MCSTEC053Z01SVR**  
Tappo alluminio verniciato\*\* RAL - sx

**MCSTEC053Z01DVR**  
Tappo alluminio verniciato\*\* RAL - dx

**MCSTEC053Z01SVX**  
Tappo alluminio verniciato\*\* legno - sx

**MCSTEC053Z01DVX**  
Tappo alluminio verniciato\*\* legno - dx

**MCSTEC053Z01SGR**  
Tappo alluminio grezzo - sinistro

**MCSTEC053Z01DGR**  
Tappo alluminio grezzo - destro

Per perlina obliqua 80x25 mm  
MCSTEC053



\*\*La quotazione a listino dei terminali in metallo verniciati è valida se abbinata a lotto di almeno 150 kg di profili nella stessa tinta oppure per lotti minimi di almeno 50 pezzi. Differentemente sarà da concordare

# MCSTEC047

PROFILO PERLINA 110x25 mm  
CON OCCHI VITE

BARRE L= 6600 mm

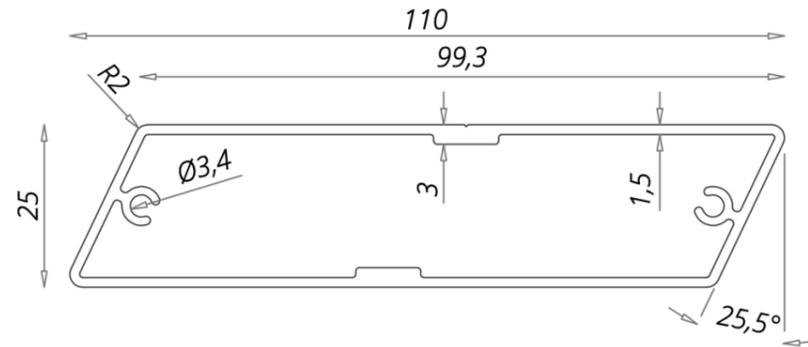

Cod. :

**MCSTEC047GR:** Grezzo

**MCSTEC047VR:** Verniciato RAL

**MCSTEC047VX:** Verniciato legno

Profilo ad H di connessione  
MCSTEC080 <—> PERLINE

**MCSTEC081GR**  
Alluminio grezzo

**MCSTEC081VR**  
Tinte RAL con lotti minimi

**MCSTEC081VX**  
Tinte Legno con lotti minimi

Barre L.6000 mm

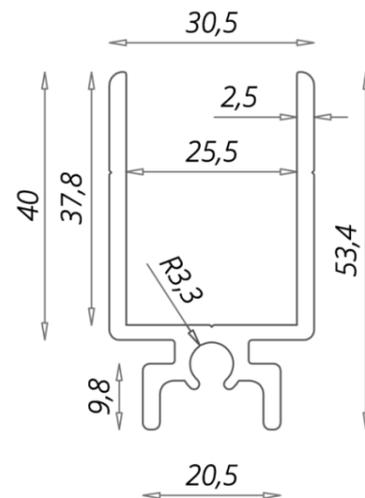

Profilo ad U di chiusura

**MCSTEC086GR**  
Alluminio grezzo

**MCSTEC086VR**  
Tinte RAL con lotti minimi

**MCSTEC086VX**  
Tinte Legno con lotti minimi

Barre L.6000 mm

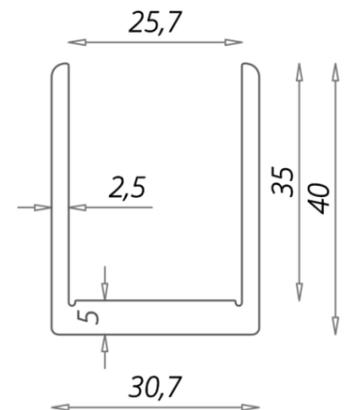

**MCSTEC047Z01SVR**  
Tappo alluminio verniciato\*\* RAL - sx

**MCSTEC047Z01DVR**  
Tappo alluminio verniciato\*\* RAL - dx

**MCSTEC047Z01SVX**  
Tappo alluminio verniciato\*\* legno - sx

**MCSTEC047Z01DVX**  
Tappo alluminio verniciato\*\* legno - dx

**MCSTEC047Z01SGR**  
Tappo alluminio grezzo - sinistro

**MCSTEC047Z01DGR**  
Tappo alluminio grezzo - destro

Per perlina obliqua 110x25 mm  
MCSTEC047



\*\*La quotazione a listino dei terminali in metallo verniciati è valida se abbinata a lotto di almeno 150 kg di profili nella stessa tinta oppure per lotti minimi di almeno 50 pezzi. Differentemente sarà da concordare



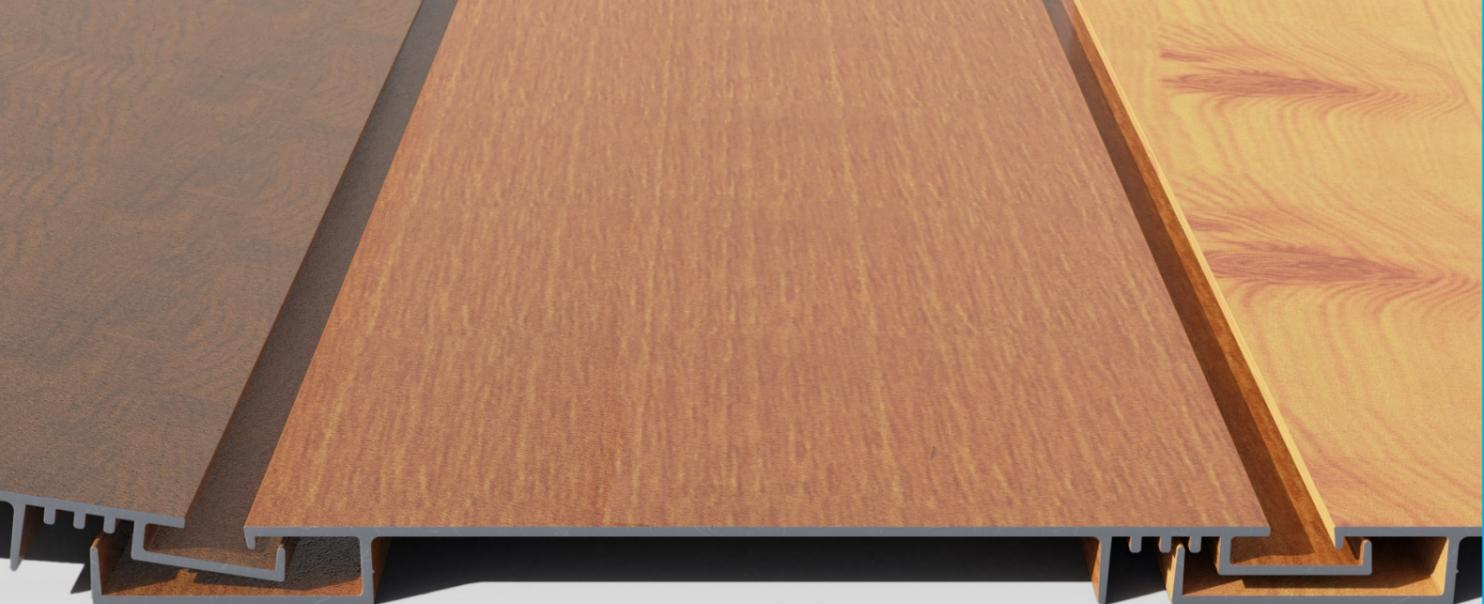

## MCSTEC088

PROFILO PER TAMPONAMENTI dim.146,8 x 10 mm

BARRE L= 6600 mm

FORNIBILE IN TUTTE LE TINTE (Lotto minimo)



**Cod. :**

**MCSTEC088GR:** Grezzo

**MCSTEC088VR:** Verniciato RAL

**MCSTEC088VX:** Verniciato legno





# MCSTEC145

PROFILO CORRIMANO 60x40 mm  
BARRE L= 6500 mm

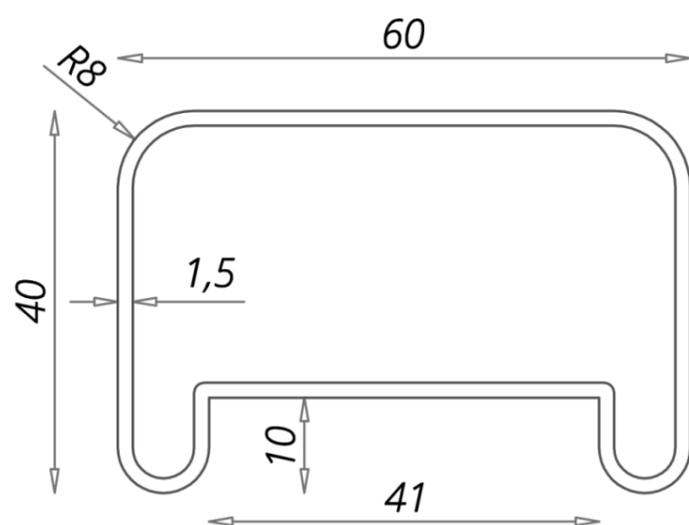

Cod. :

**MCSTEC145GR:** Grezzo

**MCSTEC145VR:** Verniciato RAL

**MCSTEC145VX:** Verniciato legno



MCSTEC145



## TAPPI TINTE LEGNO



**VS9364ZZ02VX**  
Tappo alluminio verniciato\*\* tinta legno

**VS9364ZZ02GR**  
Tappo alluminio grezzo



**VS9364ZZ01VX**  
Tappo alluminio verniciato\*\* tinta legno

**VS9364ZZ01GR**  
Tappo alluminio grezzo



\*\*La quotazione a listino dei terminali in metallo verniciati è valida se abbinata a lotto di almeno 150 kg di profili nella stessa tinta oppure per lotti minimi di almeno 50 pezzi. Differentemente sarà da concordare

## TINTE RAL



**VS9364ZZ02VR**  
Tappo alluminio verniciato\*\* tinta RAL



**VS9364ZZ01VR**  
Tappo alluminio verniciato\*\* tinta RAL

**FISSAGGIO** al piantone  
con piastra tramite viti o rivetti

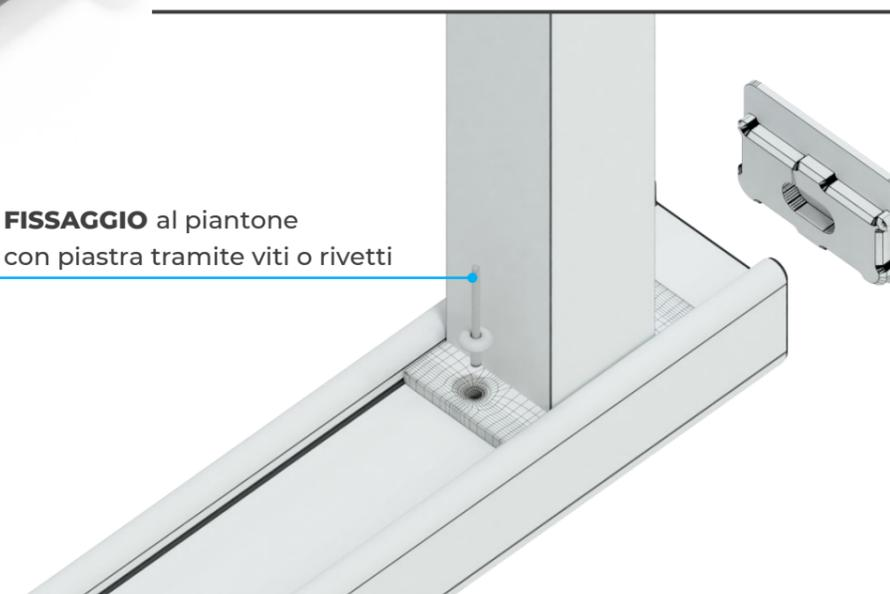

# MCSTEC150

PROFILO CORRIMANO RAGGIATO 138x37 mm  
CON OCCHI VITE

BARRE L= 7000 mm

Cod. :

**MCSTEC150GR:** Grezzo

**MCSTEC150VR:** Verniciato RAL

**MCSTEC150VX:** Verniciato legno

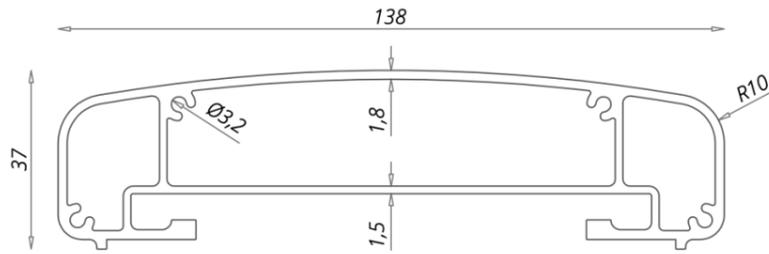

## MCSTEC160VA

Tappo alluminio verniciato\*\* antracite

## MCSTEC160VR

Tappo alluminio verniciato\*\* RAL

## MCSTEC160VX

Tappo alluminio verniciato\*\* legno

## MCSTEC160GR

Tappo alluminio grezzo

Per passamano MCSTEC150

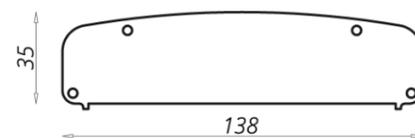

## MCSTEC161VA

Tappo alluminio verniciato\*\* antracite

## MCSTEC161VR

Tappo alluminio verniciato\*\* RAL

## MCSTEC161VX

Tappo alluminio verniciato\*\* legno

## MCSTEC161GR

Tappo alluminio grezzo

Per passamano MCSTEC150

(a richiesta)

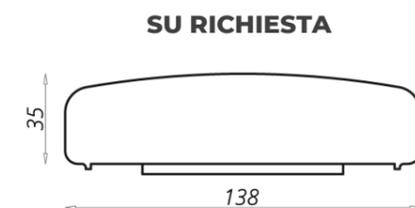

\*\*La quotazione a listino dei terminali in metallo verniciati è valida se abbinata a lotto di almeno 150 kg di profili nella stessa tinta oppure per lotti minimi di almeno 50 pezzi. Differentemente sarà da concordare

## MCSTEC101

Vite M8X25

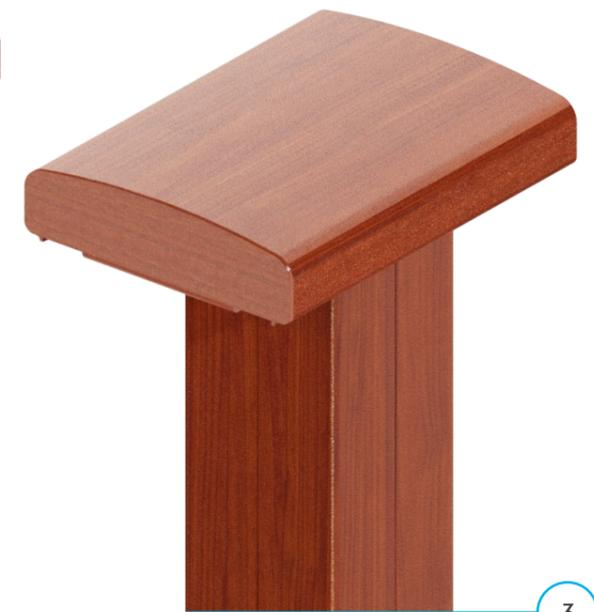

Tappo

## MCSTEC161

2



Tappo

## MCSTEC170

## MCSTEC100R

Viti auto perforanti  
con rondella 5x22 mm

Connessione

## MCSTEC038

Palo quadro 80 mm

## MCSTEC082



**CONNESSIONI PALI - PASSAMANO**



STRUTTURA ESISTENTE IN  
ACCIAIO ZINCATO



MCSTEC080



MCSTEC082



MCSTEC060

**CONNESSIONI PALI - PERLINA**



Fissaggio con viti  
auto perforanti



**MCSTEC180**

Connessione Ø32 mm per collegamento tubi quadri acciaio e passamano MCSTEC150 mediante fazzoletto MCSTEC170

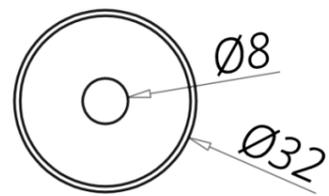
**MCSTEC170**

Fazzoletto di collegamento passamano MCSTEC150

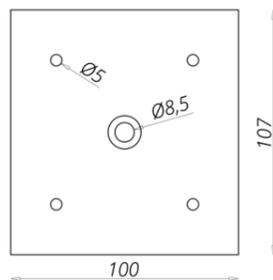
**MCSTEC155**

Squadretta fissaggio muro muro-passamano MCSTEC150

Utile anche per fissaggio palo-passamano

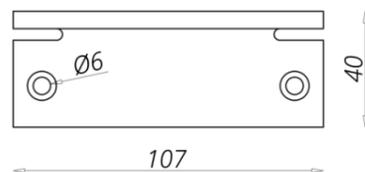

# MCSTEC140

PROFILO CORRIMANO RAGGIATO  
110x41 mm  
per basetta a scatto MCSTEC136

BARRE L= 6500 mm

Cod. :

**MCSTEC140GR:** Grezzo

**MCSTEC140VR:** Verniciato RAL

**MCSTEC140VX:** Verniciato legno

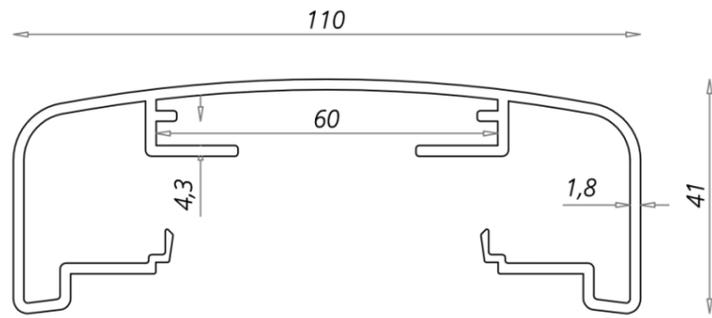

MCSTEC140



Viti autofilettanti

MCSTEC136



MCSTEC137

MCSTEC139

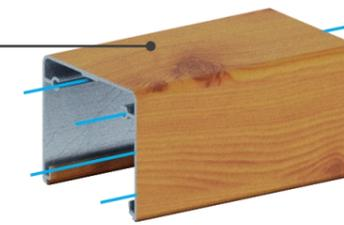

MCSTEC130

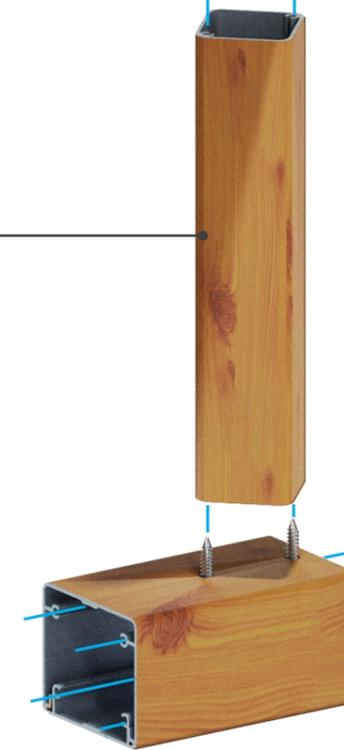

MCSTEC082





**MCSTEC140GL1**  
Giunzione lineare in alluminio  
grezzo per profilo  
corrimano MCSTEC140

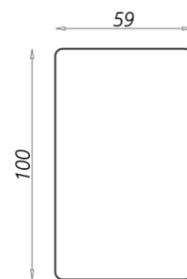

**MCSTEC140GL**  
Giunzione lineare in alluminio  
grezzo per profilo  
corrimano MCSTEC140

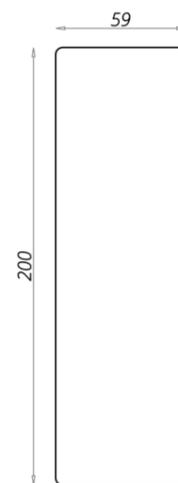
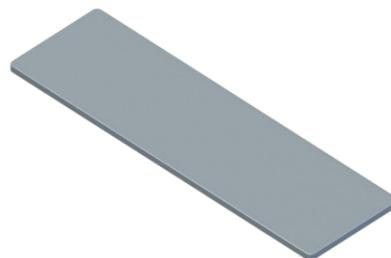

**MCSTEC140GA**  
Giunzione angolare in alluminio  
grezzo per profilo  
corrimano MCSTEC140

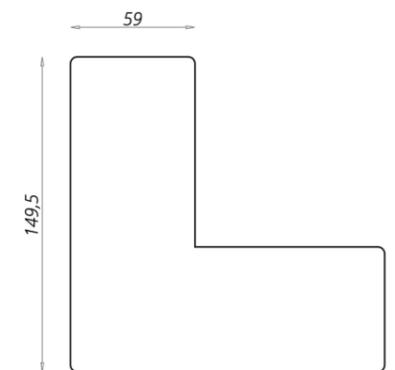
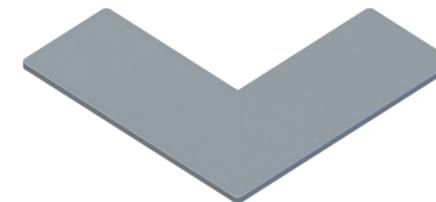

**MCSTEC140ZZ01VR**  
Tappo alluminio verniciato\*\* RAL  
**MCSTEC140ZZ01VX**  
Tappo alluminio verniciato\*\* legno  
**MCSTEC140ZZ01GR**  
Tappo alluminio grezzo

Per passamano + basetta  
MCSTEC140 + MCSTEC136

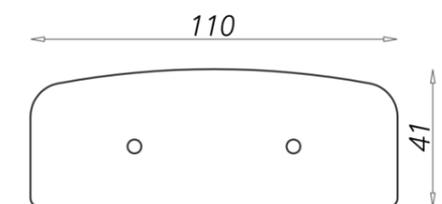

\*\*La quotazione a listino dei terminali in metallo verniciati è valida se abbinata a lotto di almeno 150 kg di profili nella stessa tinta oppure per lotti minimi di almeno 50 pezzi. Differentemente sarà da concordare



# MCSTEC136

PROFILO BASETTA A SCATTO 60x14 mm  
per accoppiamento a scatto con:  
MCSTEC137  
MCSTEC139  
MCSTEC140

BARRE L= 6500 mm

**Cod.:**

**MCSTEC136GR:** Grezzo

**MCSTEC136VR:** Verniciato RAL

**MCSTEC136VX:** Verniciato legno

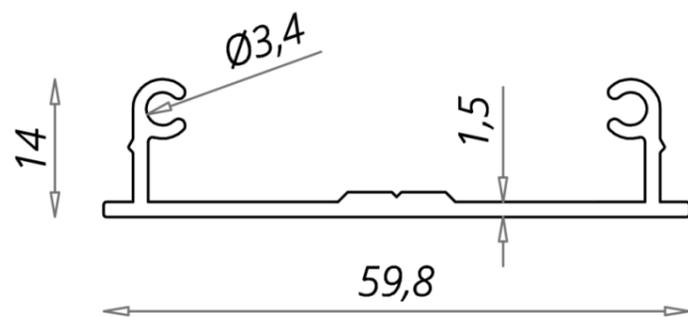

# MCSTEC137

PROFILO SPALLETTA 70x20 mm  
per basetta a scatto MCSTEC136

BARRE L= 6500 mm

Cod. :

**MCSTEC137GR:** Grezzo

**MCSTEC137VR:** Verniciato RAL

**MCSTEC137VX:** Verniciato legno

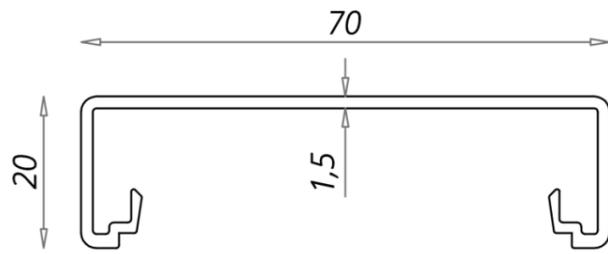

MCSTEC136



MCSTEC082

## MCSTEC137ZZ01VR

Tappo alluminio verniciato\*\* RAL

## MCSTEC137ZZ01VX

Tappo alluminio verniciato\*\* legno

## MCSTEC137ZZ01GR

Tappo alluminio grezzo

Per spalletta + basetta  
MCSTEC137 + MCSTEC136

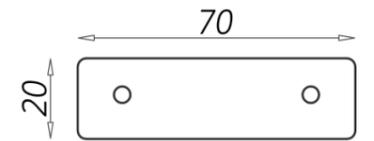

## MCSTEC08201ZZVR

Tappo alluminio verniciato\*\* RAL

## MCSTEC08201ZZVX

Tappo alluminio verniciato\*\* legno

## MCSTEC08201ZZGR

Tappo alluminio grezzo

Per spalletta + palo quadro  
MCSTEC137 + MCSTEC082

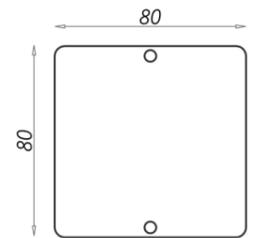

## MCSTEC082ZZ01VR

Tappo alluminio verniciato\*\* RAL

## MCSTEC082ZZ01VX

Tappo alluminio verniciato\*\* legno

## MCSTEC082ZZ01GR

Tappo alluminio grezzo

Per palo quadro MCSTEC082

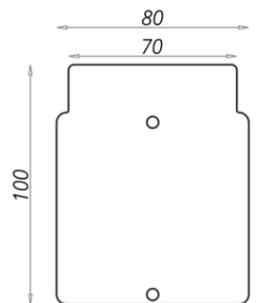
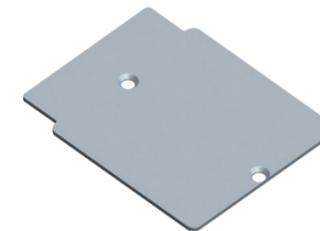

## MCSTEC082ZZ02VR

Tappo alluminio verniciato\*\* RAL

## MCSTEC082ZZ02VX

Tappo alluminio verniciato\*\* legno

## MCSTEC082ZZ02GR

Tappo alluminio grezzo

Per spalletta + palo quadro  
MCSTEC137 + MCSTEC082

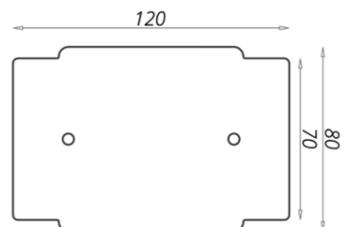
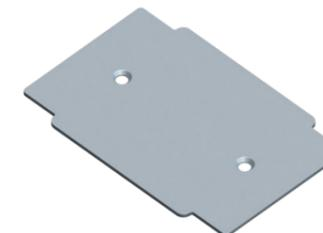

## MCSTEC082ZZ03VR

Tappo alluminio verniciato\*\* RAL

## MCSTEC082ZZ03VX

Tappo alluminio verniciato\*\* legno

## MCSTEC082ZZ03GR

Tappo alluminio grezzo

Per spalletta + palo quadro  
MCSTEC137 + MCSTEC082

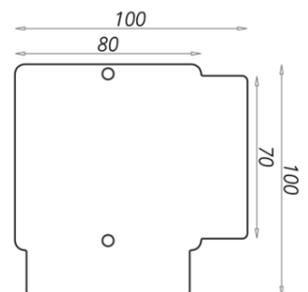
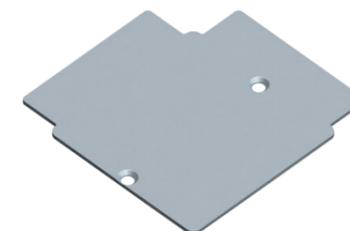

\*\*La quotazione a listino dei terminali in metallo verniciati è valida se abbinata a lotto di almeno 150 kg di profili nella stessa tinta oppure per lotti minimi di almeno 50 pezzi. Differentemente sarà da concordare





# MCSTEC139

SPALLA A SCATTO 66x55 mm  
per basetta a scatto MCSTEC136

BARRE L= 6500 mm

Cod. :

**MCSTEC139GR:** Grezzo

**MCSTEC139VR:** Verniciato RAL

**MCSTEC139VX:** Verniciato legno

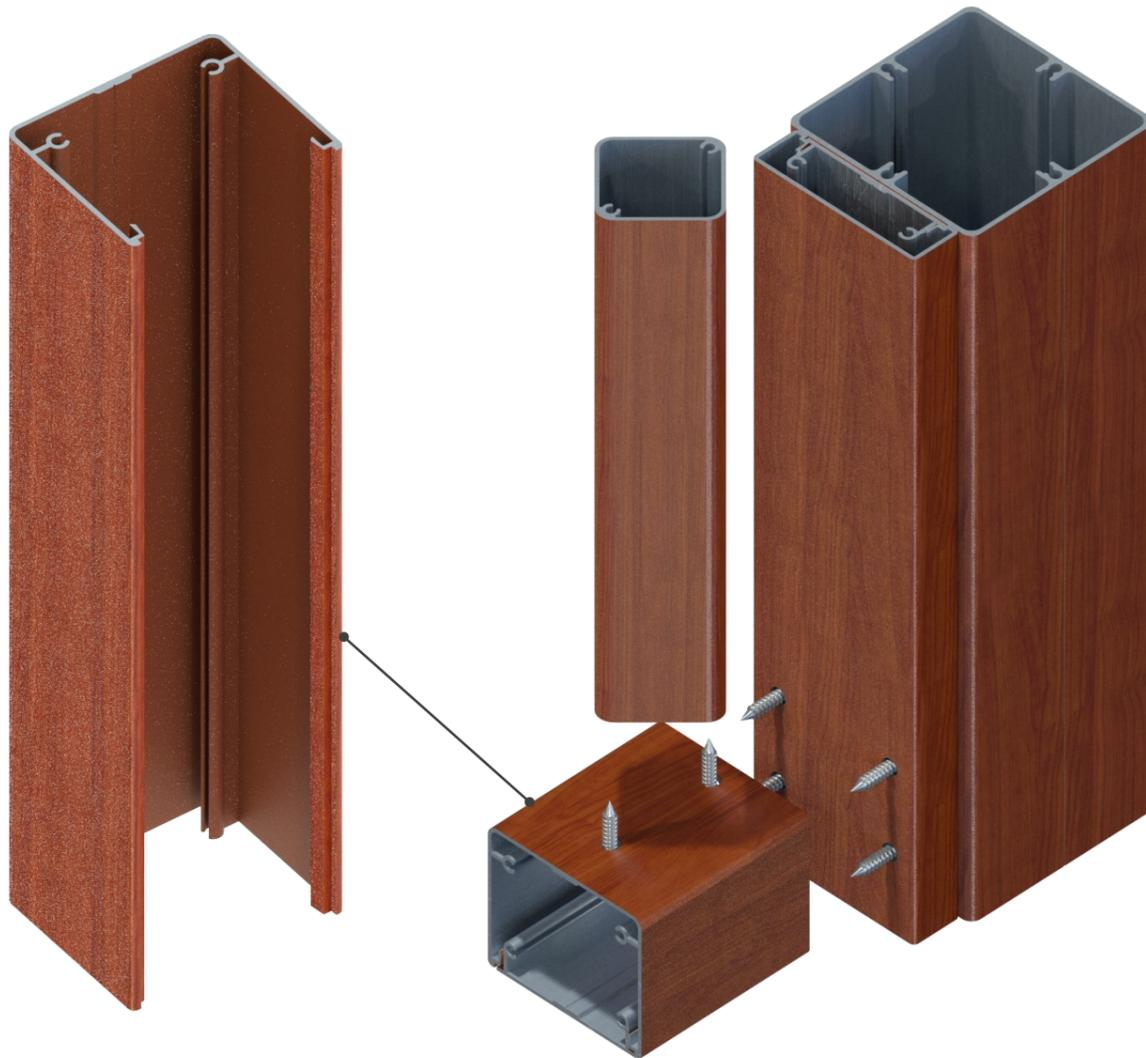
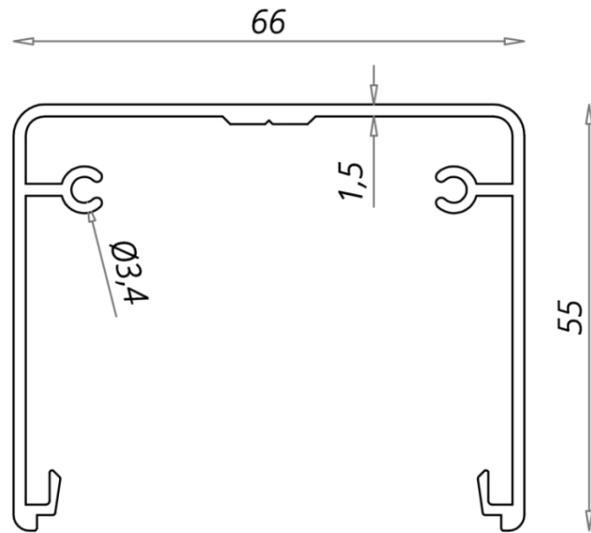

## MCSTEC139ZZ01VR

Tappo alluminio verniciato\*\* RAL

## MCSTEC139ZZ01VX

Tappo alluminio verniciato\*\* legno

## MCSTEC139ZZ01GR

Tappo alluminio grezzo

Per spalla + basetta  
MCSTEC139 + MCSTEC136

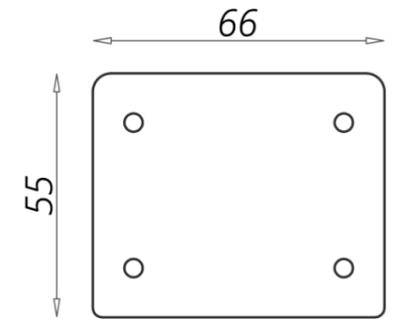

\*\*La quotazione a listino dei terminali in metallo verniciati è valida se abbinata a lotto di almeno 150 kg di profili nella stessa tinta oppure per lotti minimi di almeno 50 pezzi. Differentemente sarà da concordare





# MCSTEC060

PROFILO PALO ARROTONDATO 90x90 mm  
BARRE L= 6500 mm

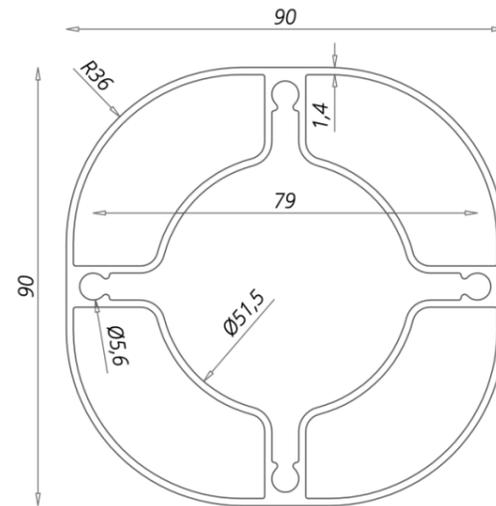

Cod. :

**MCSTEC060GR:** Grezzo

**MCSTEC060VR:** Verniciato RAL

**MCSTEC060VX:** Verniciato legno

## MCSTEC020

Tappo bombato in alluminio per palo 90 mm MCSTEC060

(Disponibile: grezzo, verniciato\*\* tinta RAL e verniciato tinta legno)

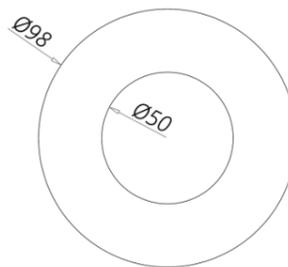

## MCSTEC035

Connessione Ø50mm con fori per MCSTEC060 / perline

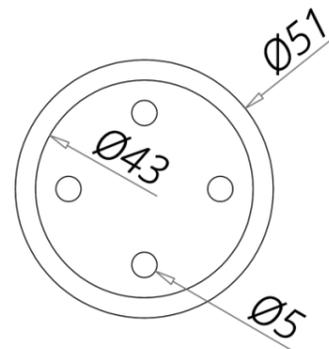

\*\*La quotazione a listino dei terminali in metallo verniciati è valida se abbinata a lotto di almeno 150 kg di profili nella stessa tinta oppure per lotti minimi di almeno 50 pezzi. Differentemente sarà da concordare

## MCSTEC072

Base in acciaio zincato interna Ø50 mm per palo MCSTEC060  
(fissaggio con tasselli)

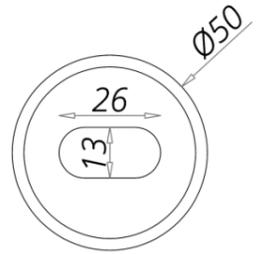

## MCSTEC110\*

Base in acciaio zincato per palo, con puntale  
(fissaggio nel terreno)

**\*fino ad esaurimento**

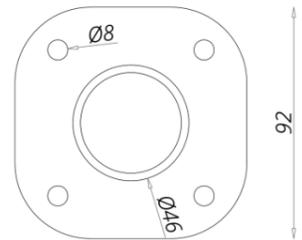

## MCSTEC070

Base tonda in acciaio zincato per palo da 90mm MCSTEC060  
(fissaggio con tasselli)

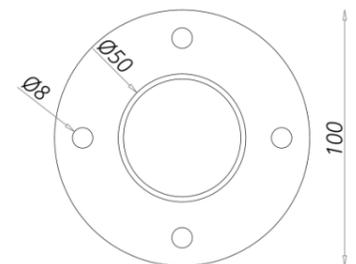

## MCSTEC071

Base sagomata in acciaio zincato per palo da 90mm MCSTEC060  
(fissaggio con tasselli)

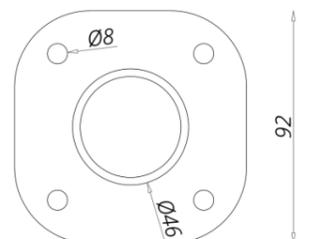

# MCSTEC080

PROFILO PALO RAGGIATO 80x80 mm  
BARRE L= 6500 mm

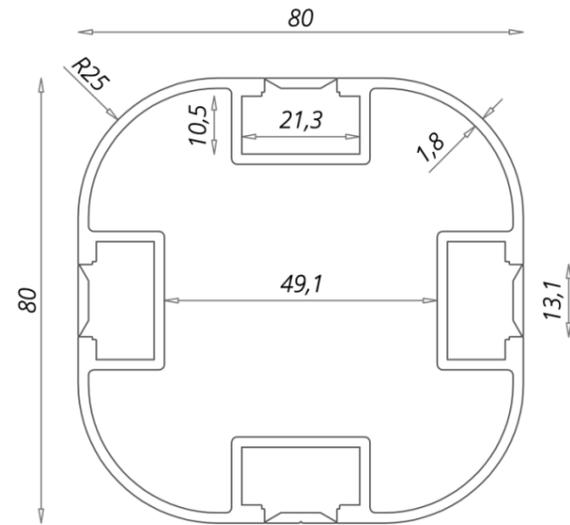

Cod. :

**MCSTEC080GR:** Grezzo

**MCSTEC080VR:** Verniciato RAL

**MCSTEC080VX:** Verniciato legno

MCSTEC048 /49/50/51/52/53

MCSTEC081

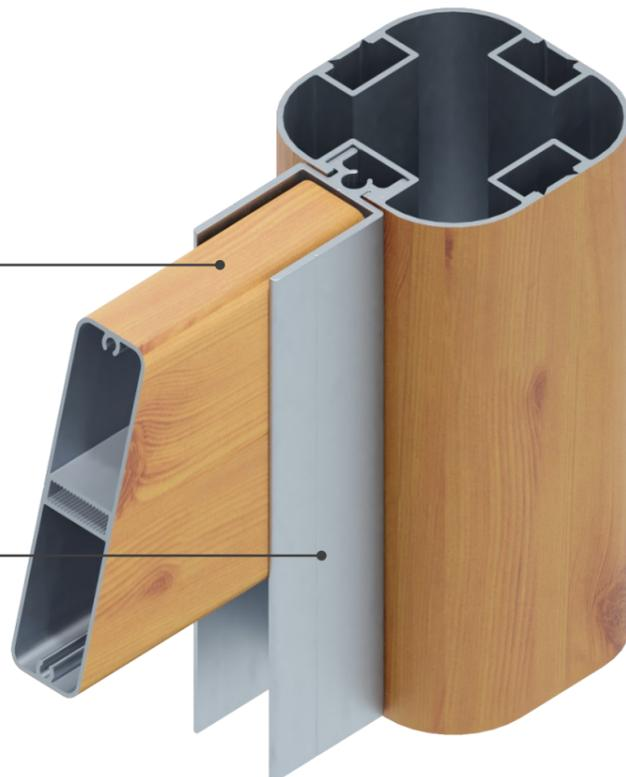

## MCSTEC013

Tappo in alluminio per  
palo 80 mm MCSTEC080

(Disponibile: grezzo,  
verniciato tinta RAL e  
verniciato tinta legno)



Profilo ad H di connessione  
MCSTEC080 <—> PERLINE

**MCSTEC081GR**  
Alluminio grezzo

**MCSTEC081VR**  
Tinte RAL con lotti minimi

**MCSTEC081VX**  
Tinte Legno con lotti minimi

Barre L.6000 mm

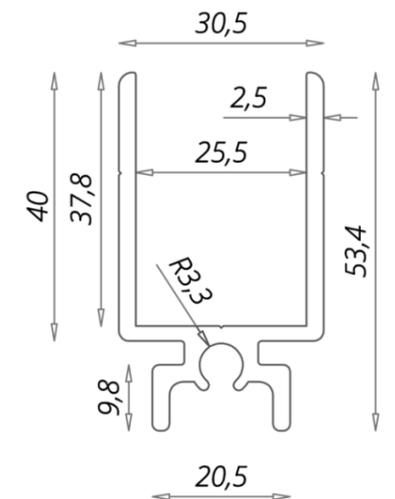

Profilo ad U di chiusura  
per perline da 25mm

**MCSTEC086GR**  
Alluminio grezzo

**MCSTEC086VR**  
Tinte RAL con lotti minimi

**MCSTEC086VX**  
Tinte Legno con lotti minimi

Barre L.6000 mm

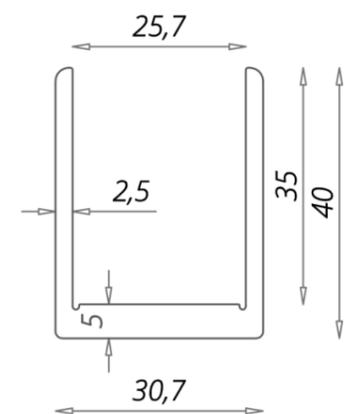



# MCSTEC082

PROFILO PALO QUADRO 80x80 mm  
BARRE L= 6500 mm

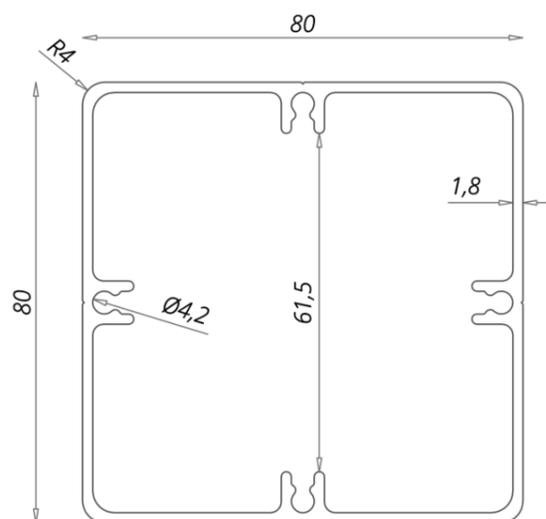

Cod. :

**MCSTEC082GR:** Grezzo

**MCSTEC082VR:** Verniciato RAL

**MCSTEC082VX:** Verniciato legno

## MCSTEC073

Base in acciaio zincato interna  
Ø60 mm per palo MCSTEC082  
(fissaggio con tasselli)

(Produzione su richiesta)

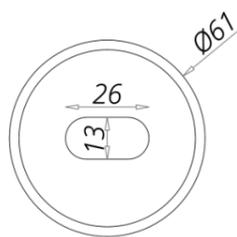

## MCSTEC037

Connessione Ø61 mm con fori tra  
MCSTEC082 e profilo passamano  
MCSTEC150

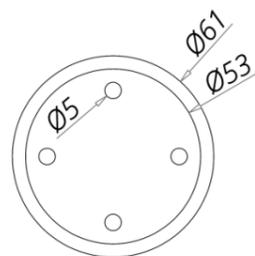

## MCSTEC038

Connessione Ø61 mm con foro  
centrale Ø8 per MCSTEC082 e  
profilo passamano MCSTEC150

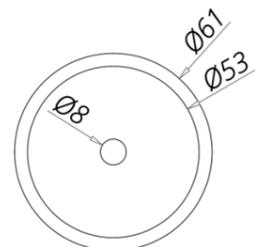

## MCSTEC082ZR

Tappo in plastica disponibile in tinte RAL  
(lotto minimo: 51 pezzi per colore)

## MCSTEC082ZS

Tappo in plastica sublimato con grafica  
personalizzata.  
(lotto minimo: 51 pezzi per colore)

Per profilo quadro 80x80 mm MCSTEC082

## MCSTEC082ZZ01VR

Tappo alluminio verniciato\*\* RAL

## MCSTEC082ZZ01VX

Tappo alluminio verniciato\*\* legno

## MCSTEC082ZZ01GR

Tappo alluminio grezzo

Per palo quadro MCSTEC082

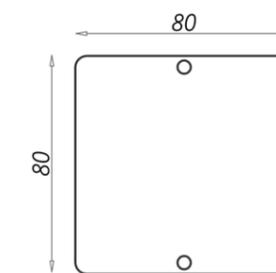

## MCSTEC015GR:

Grezzo

**MCSTEC015VR:** Verniciato RAL

**MCSTEC015VX:** Verniciato effetto legno

Tappo quadro in acciaio zincato.  
Verniciato per palo quadro MCSTEC082 -  
80x80mm

Disponibile grezzo,  
verniciato\*\* mazzato marrone e verde

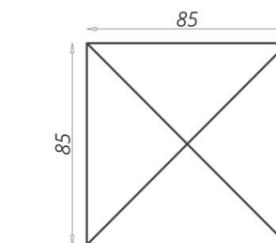
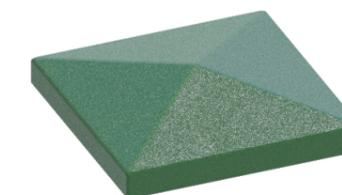

## MCSTEC018GR:

Grezzo

**MCSTEC018VR:** Verniciato RAL

**MCSTEC018VX:** Verniciato effetto legno

Tappo quadro in acciaio zincato.  
Verniciato per palo quadro MCSTEC085 -  
100x100mm

Disponibile grezzo,  
verniciato\*\* mazzato marrone e verde

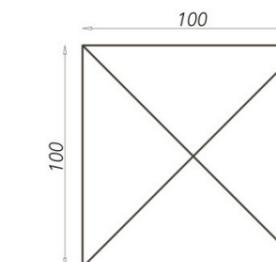

\*\*La quotazione a listino dei terminali in metallo verniciati è valida se abbinata a lotto di almeno 150 kg di profili nella stessa tinta oppure per lotti minimi di almeno 50 pezzi. Differentemente sarà da concordare



# MCSTEC130

PROFILO QUADRO RAGGIATO 40x40 mm  
CON OCCHI VITE

BARRE L= 6500 mm

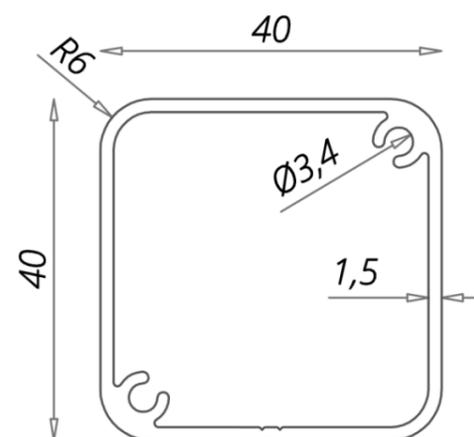

Cod. :

**MCSTEC130GR:** Grezzo

**MCSTEC130VR:** Verniciato RAL

**MCSTEC130VX:** Verniciato legno



**MCSTEC131ZZ01VR**

Tappo alluminio verniciato\*\* RAL

**MCSTEC131ZZ01VX**

Tappo alluminio verniciato\*\* legno

**MCSTEC131ZZ01GR**

Tappo alluminio grezzo

Per paletto 40x40 mm. MCSTEC130

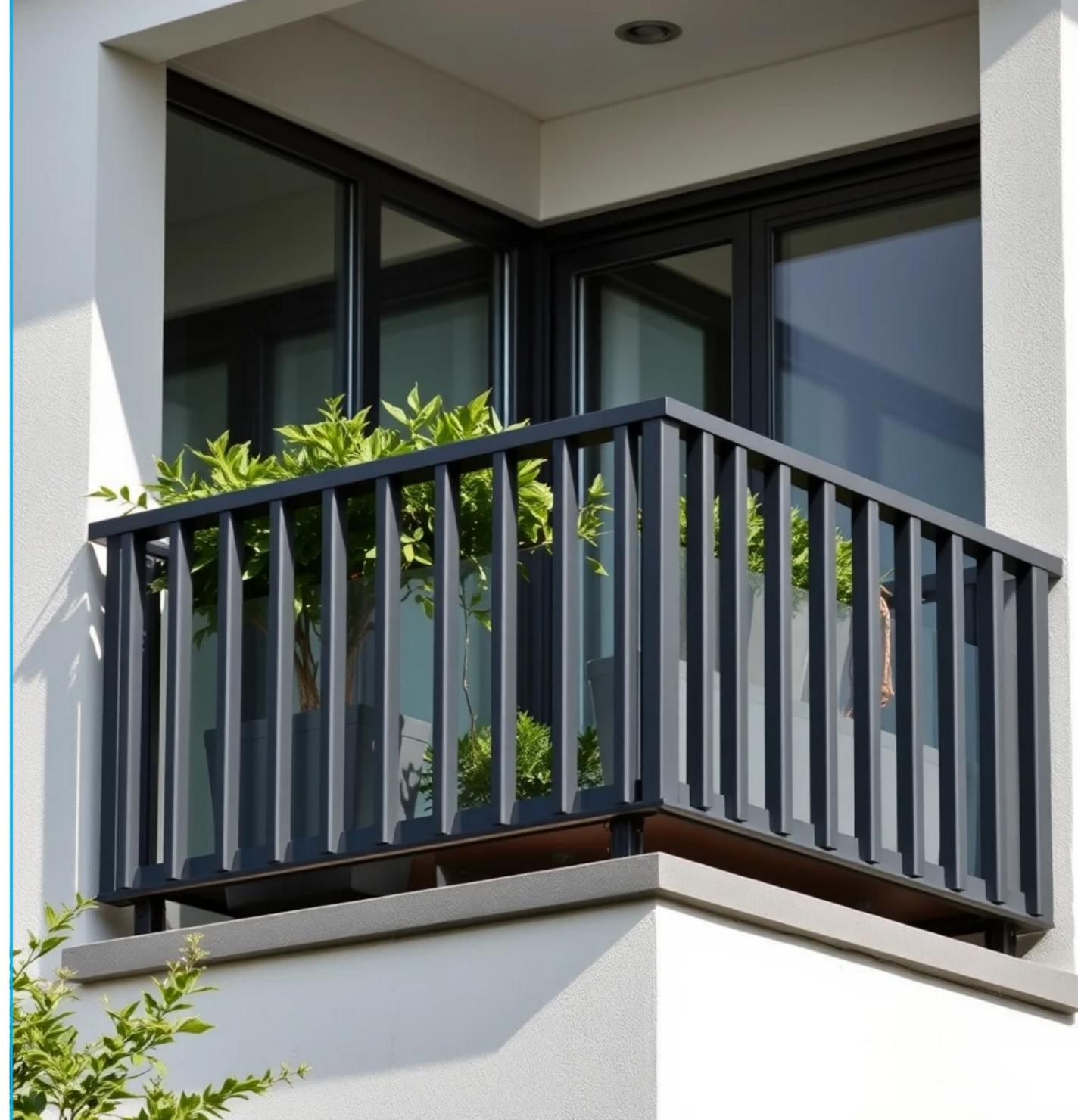

\*\*La quotazione a listino dei terminali in metallo verniciati è valida se abbinata a lotto di almeno 150 kg di profili nella stessa tinta oppure per lotti minimi di almeno 50 pezzi. Differentemente sarà da concordare



# PAD35498

**Cod.:**  
**PAD35498:** Grezzo

PROFILO CORRIMANO RAGGIATO 110x37 mm

(DA PRODUZIONE)

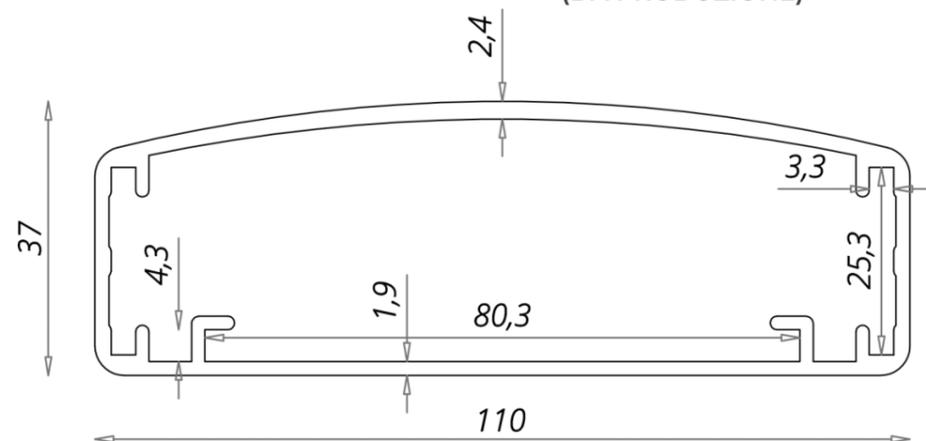

# PAD00694

**Cod.:**  
**PAD00694:** Grezzo

PROFILO TUBOLARE con ogive  
Dim. 80x40 mm

(DA PRODUZIONE)

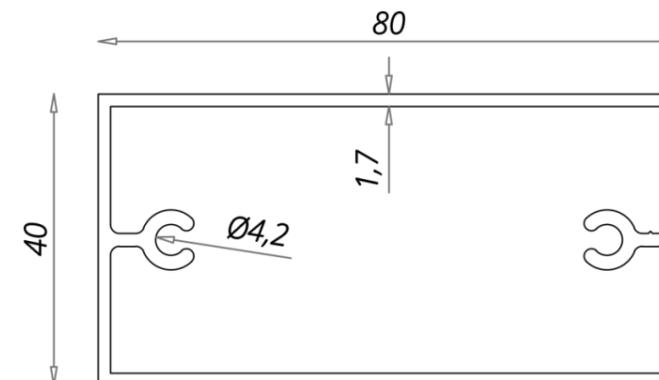

# PAD35499

**Cod.:**  
**PAD35499:** Grezzo

PROFILO TUBOLARE con ogive  
Dim. 50x65 mm

(DA PRODUZIONE)

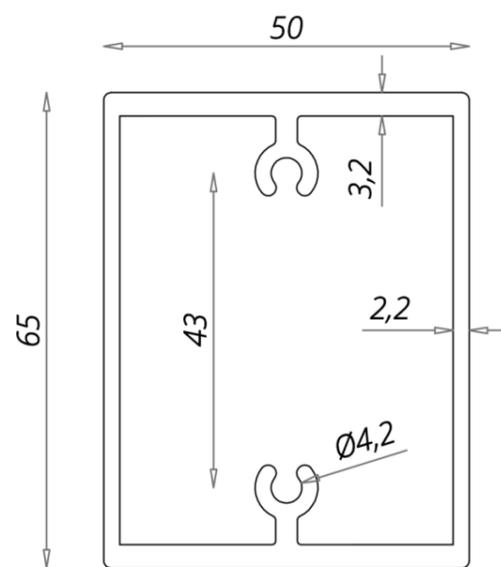

Standard

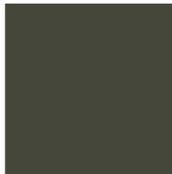
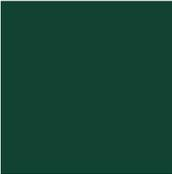
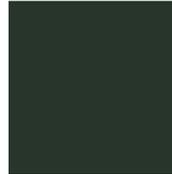
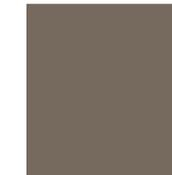
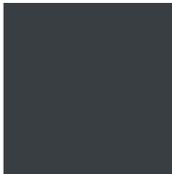
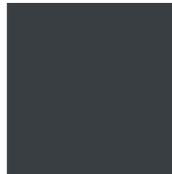
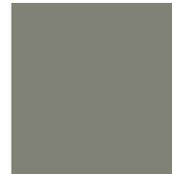
 005	 006	 007	 008	 016	 1013 OP	 1013 SL
 1019	 1019 OP	 1062	 118	 2002	 3000	 3002
 3003	 5003	 5007	 5010	 5012	 5015	 6002
 6003	 6005 LU	 6005 OP	 6009 OP	 6011 OP	 6012 SL	 6019 OP
 6021 OP	 6029	 7001	 7001 OP	 7005	 7005 OP	 7006 OP
 7012	 7016 LU	 7016 OP	 7033 OP	 7035	 7035 OP	 7037 OP
 7040 OP	 7042	 7042 OP	 7044	 7047	 8001 OP	 8003 OP

Standard

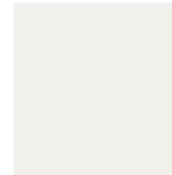
 8011 OP	 8014	 8016	 8017 OP	 8019	 8028 OP	 9001 LU
 9001 OP	 9002 SO	 9003 OP	 9004 OP	 9005 LU	 9006	 9007 OP
 9010	 9010 OP	 9016 OP	 9016 SL	 Argento	 Bronzo	



## Texturizzati



## Architettura



Tinte RAL "Texturizzati" e "Architettura" disponibili su richiesta, così come Tinte RAL non presenti sul catalogo

Tinte RAL "Texturizzati" e "Architettura" disponibili su richiesta, così come Tinte RAL non presenti sul catalogo







Castagno 375/8R (STAND.)



Castagno 378/RS (STAND.)



Ciliegio 37/70 R



Ciliegio 37/80 R



Ciliegio B8/R



Ciliegio S12/R



Ciliegio verde



Douglas 35/70 R



Douglas 35/80 R



Green Mirror



Grey Mirror



Light blue mirror



Mogano M49/R



Noce 12/70 R



Noce 360/7 R



Noce 363/7 R



Noce grigio



Noce S1/R



Noce verde



Pino 39/70R



Pino B3/R



Quercia chiaro (STANDARD)



Quercia scuro (STANDARD)



Renolit chiaro (STANDARD)



Renolit scuro (STANDARD)



Renwood scuro (STAND.)



Rovere 215 (STANDARD)



Rovere 398/B (STANDARD)



Rovere 474/RC (STAND.)



Rovere antico (STANDARD)



**Ruvide**



Rovere L280 (STANDARD)



Rovere rustico (STANDARD)



Tek s13/R (STANDARD)



Ciliegio 317-80/R



Douglas-335-80/R



Pino-319-80/R



Tek verde



Verde V7



Winchester ruvido (STAND.)



Rovere-P-80/R



Noce 310-70/R



Rovere 334-70/R



Castagno 378-70/R



Ciliegio 317-70/R



Noce 102-70/R



Noce 360-70/R



## Lisce



Ciliegio 317-80



Douglas 202-80



Rovere 333-80



Rovere 258-80



Pino 319-80



Douglas 335-80



Ciliegio 332-70



Douglas 335-70



Noce 102-70



Noce B-70



Rovere 302-70



Acacia A-70



Ciliegio 317-70



Rovere E-70

## Ruvide



Castano 375-73/R



Rovere Sbiancato 498-137/R



Rovere Antico 474-73/R



Rovere 414-73/R



Rovere 398-87/R



Quercia Chiara 386-73/R



Quercia Scura 387-70/R

